

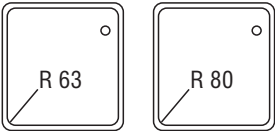

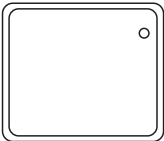

# БАНА ЗА ВГРАЖДАНЕ

		Размери mm	COD
		400x400x200	D02.142
		400x400x250	D02.142
		400x400x300	D02.142
		500x400x200	D02.145
		500x400x250	D02.146
		500x400x300	D02.147
		500x500x200	D02.148
		500x500x250	D02.149
		500x500x300	D02.150

		Размери mm	COD
		600x450x300	D02.152
		600x450x350	D02.153
		600x500x250	D02.154
		600x500x300	D02.155
		600x500x320	D02.157
		600x500x350	D02.156

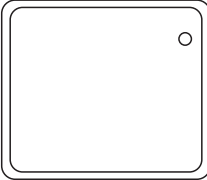
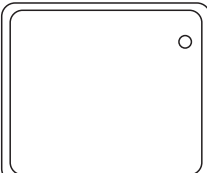
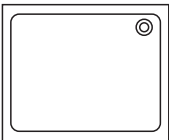
		Размери mm	COD
		290x340xh.180	D02.131
		290x340xh.200	D02.132
		290x340xh.220	D02.133
		290x400xh.200	D02.134
		330x330xh.160	D02.130
		330x330xh.180	D02.135
		330x330xh.200	D02.136

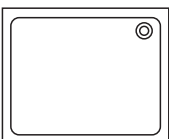
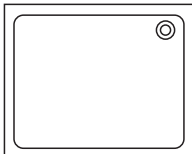
		Размери mm	COD
		340x400xh.160	D02.137
		340x400xh.180	D02.138
		340x400xh.200	D02.139

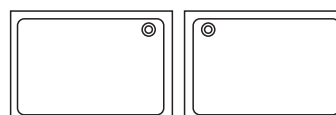

h = 150 mm  
h = 180 mm  
h = 230 mm  
h = 270 mm  
h = 320 mm

## PFB. 1

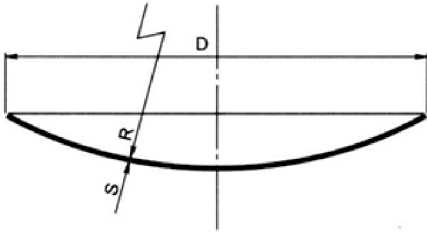

D = по поръчка  
R = по поръчка  
S = 2 ÷ 80

## PFB. 2

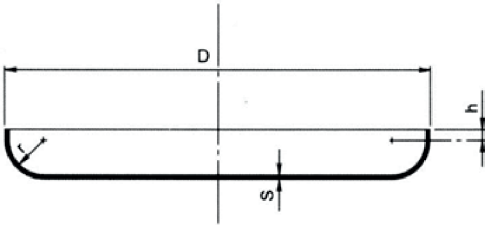

D = 300 ÷ 6500  
r = 10 ÷ 300  
S = 2 ÷ 35  
h = 5 x S

## PFB. 3

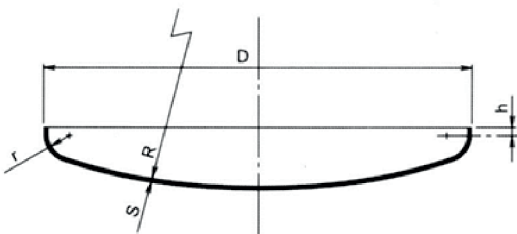

D = 300 ÷ 6500  
r = 10 ÷ 300  
S = 2 ÷ 35  
h = 5 x S

## PFB. 4

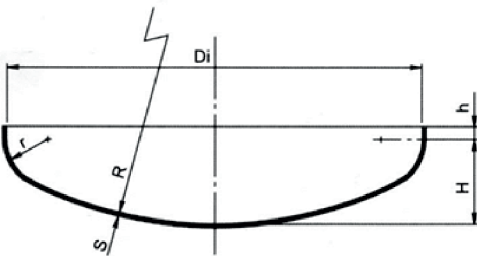

D = 300 ÷ 6500  
R = Di  
r = Di/10  
H = Di/5  
S = 2 ÷ 35  
h = 5 x S  
обем = 0,1 x Di<sup>3</sup> ( без цилиндричната зона)

## PFB. 5

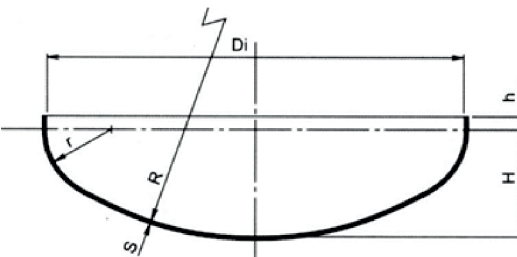

D = 300 ÷ 6500  
R = 0.833 x Di  
r = 0.165 x Di  
H = Di : 4  
S = 3 ÷ 35  
h = 5 x S  
обем = 0,1298 x Di<sup>3</sup> ( без цилиндрична зона)

## PFB. 6

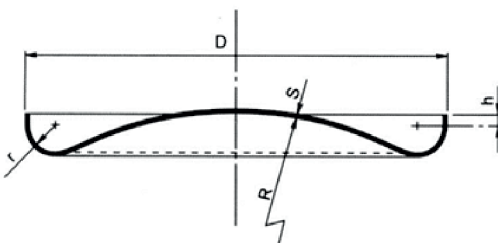

D = 300 ÷ 6500  
R = по поръчка  
r = 30 ÷ 300  
S = 2 ÷ 35  
h = 5 x S

### PFB. 7

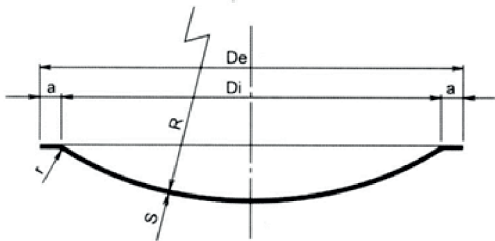

De = 300 ÷ 6500

R = по поръчка

r = 10 ÷ 50

S = 2 ÷ 35

a = по поръчка

### PFB. 8

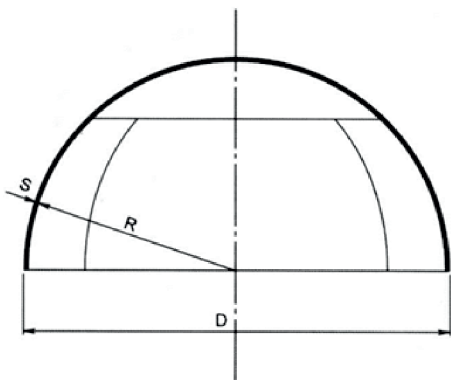

D = по поръчка

S = 3 ÷ 60

### PFB. 9

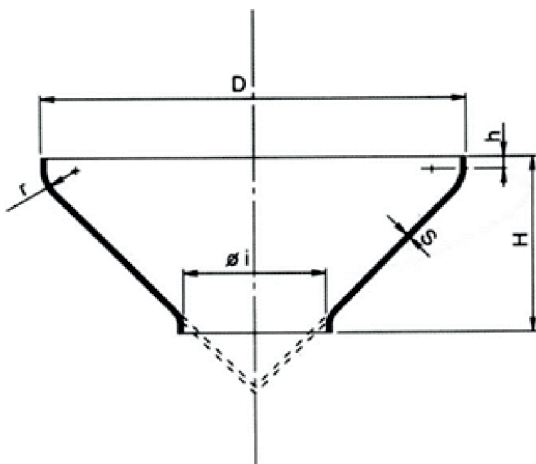

D = 400 ÷ 6500

r = 30 ÷ 500

S = 2 ÷ 35

h = 5 x S

H = по поръчка

Øi = по поръчка

### PFB. 10

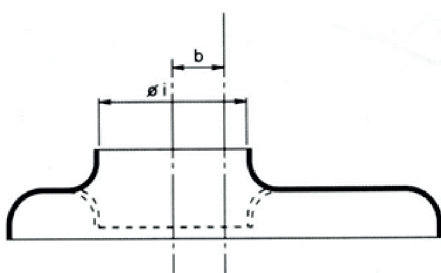

Øi = по поръчка

b = по поръчка

### PFB. 11

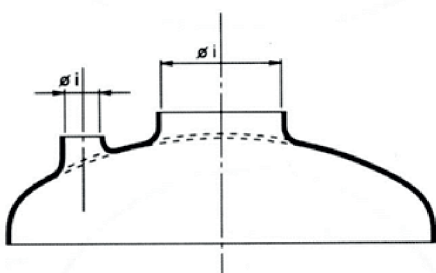

Øi = по поръчка

Отворите могат да се направят на всеки тип дъно